

Media Tensión 116x116x90 Arroyo

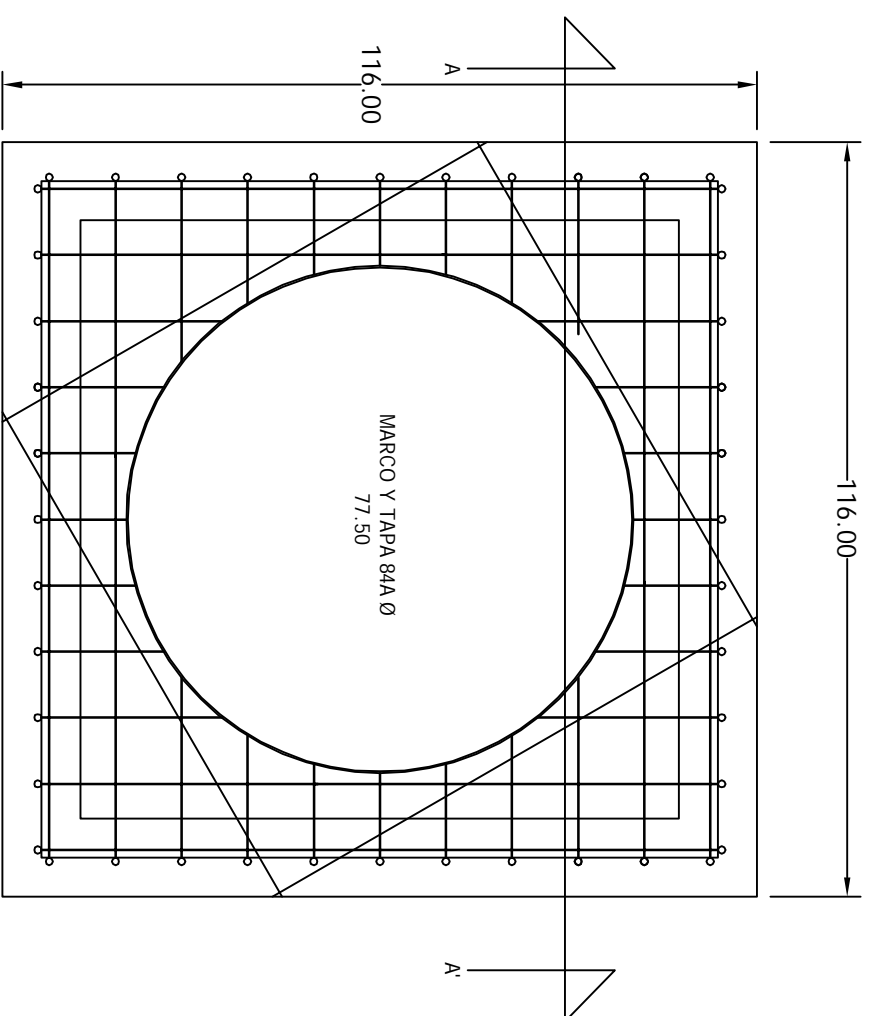

PLANTA TAPA

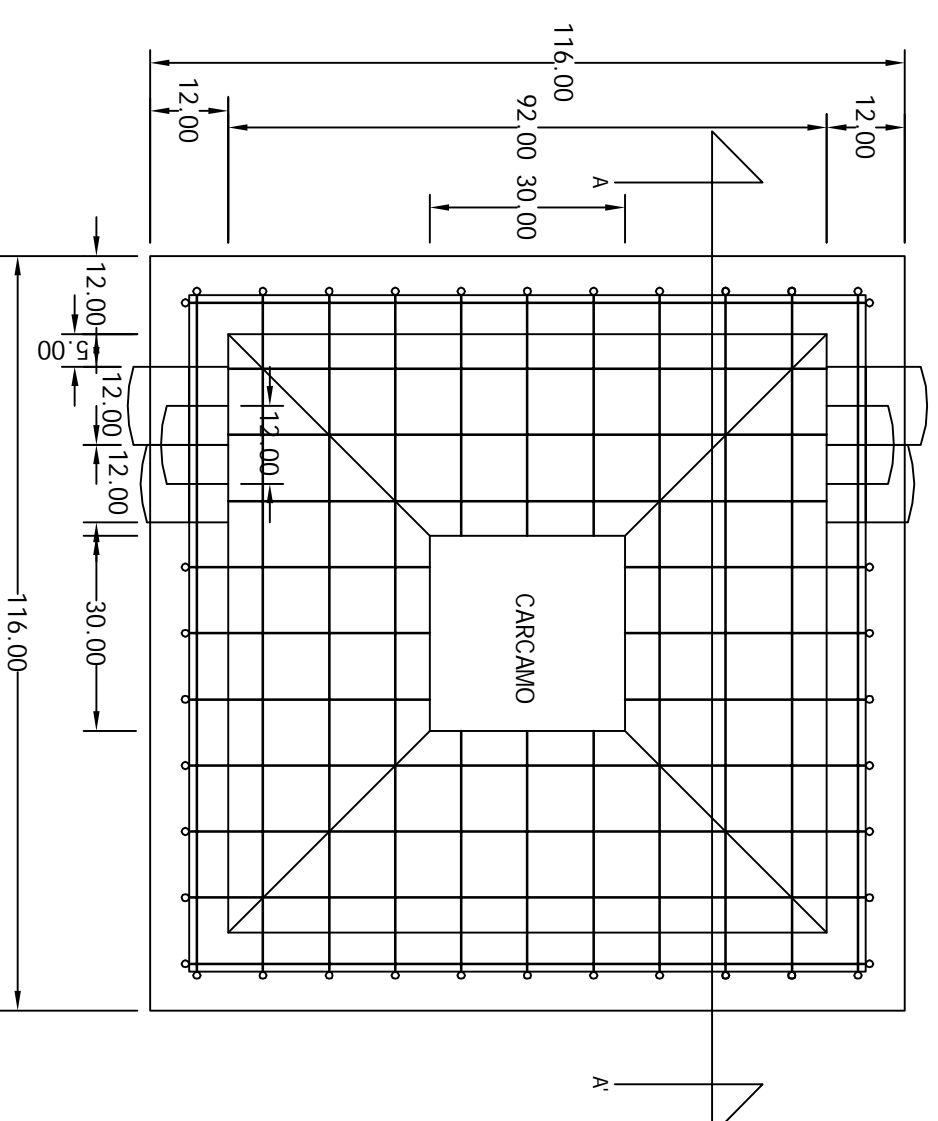
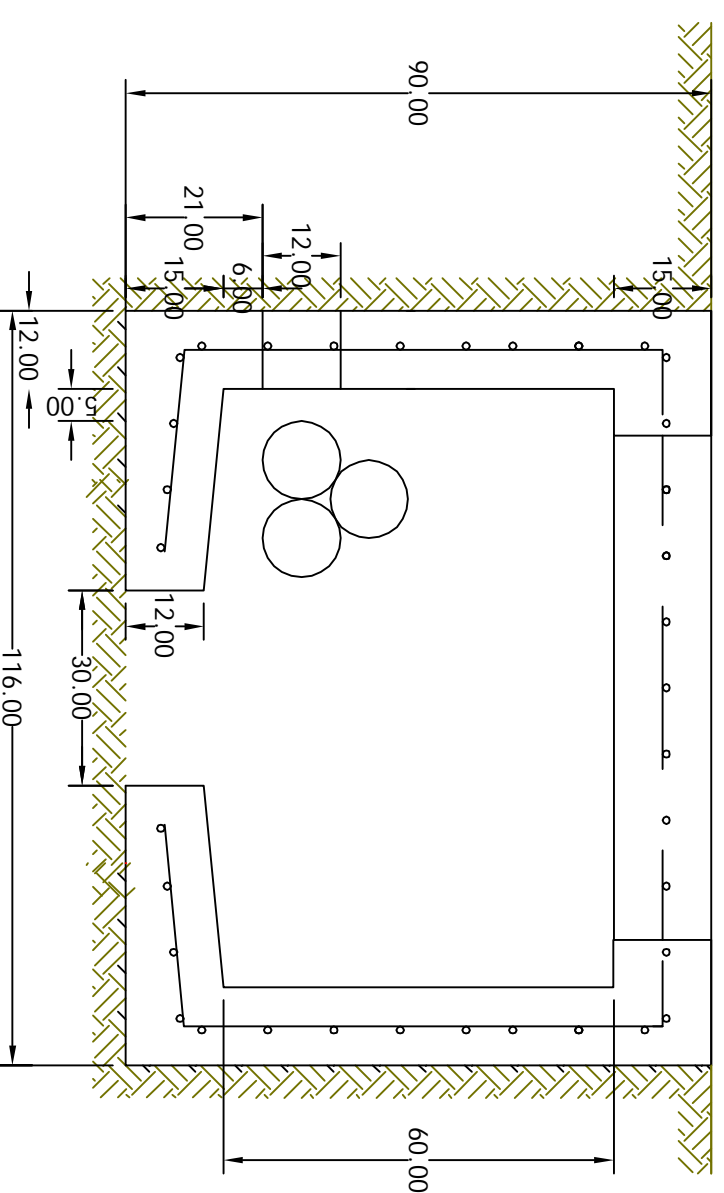
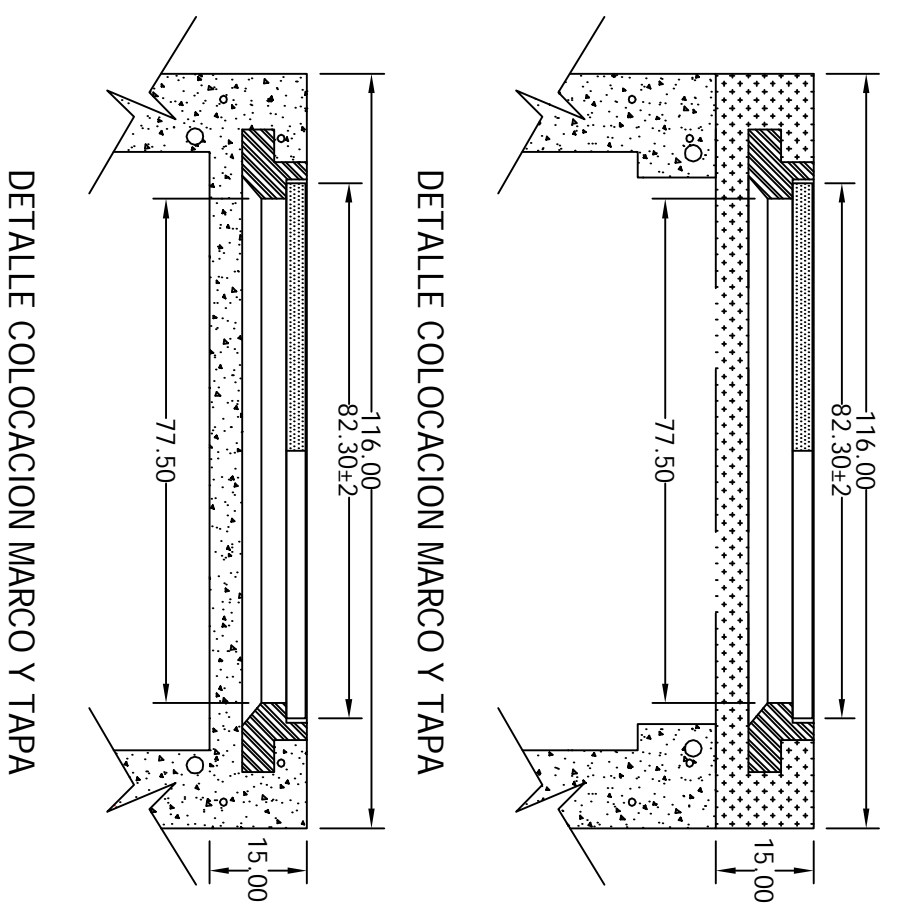
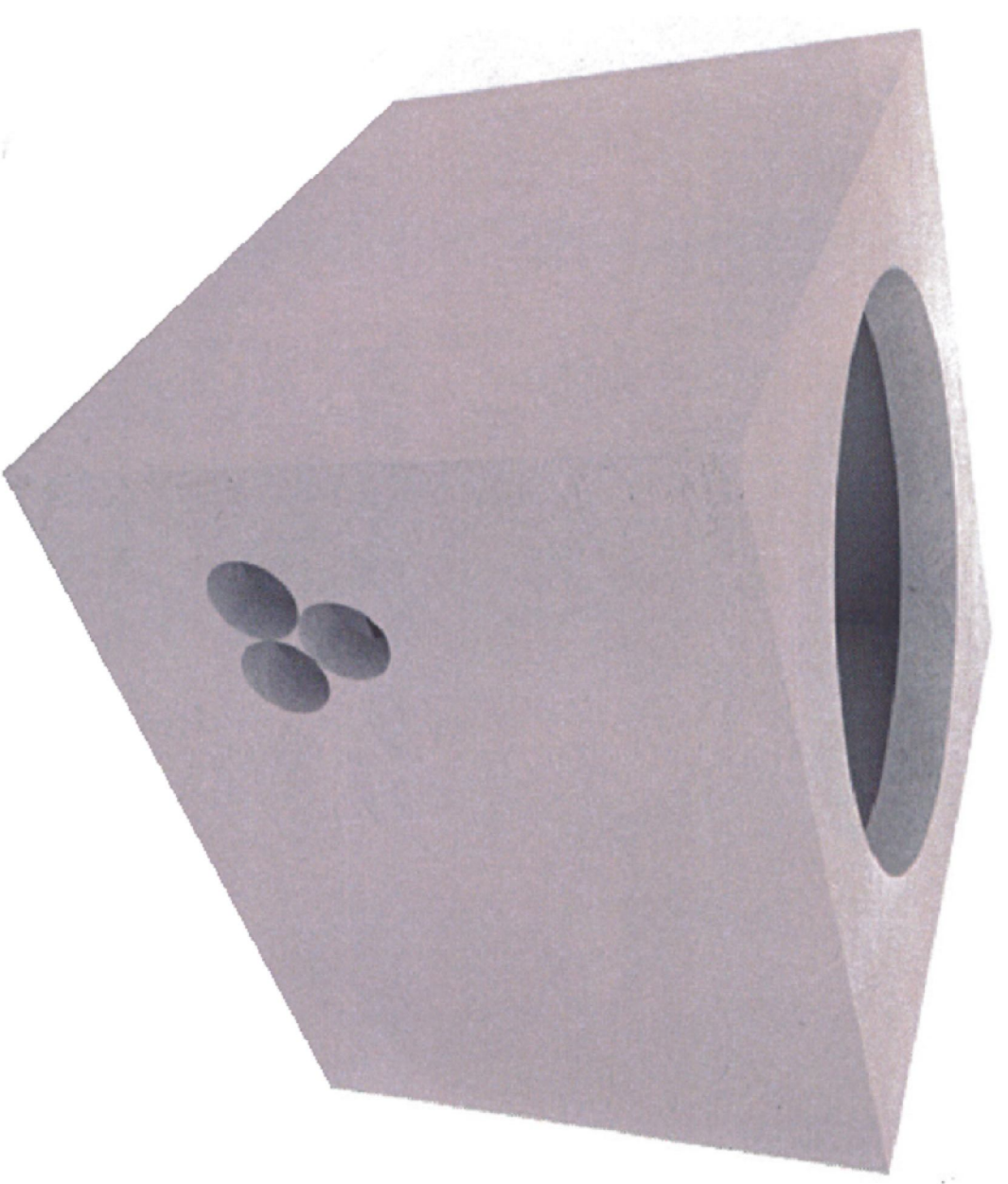

DETALLE COLOCACION MARCO Y TAPA

DETALLE COLOCACION MARCO Y TAPA

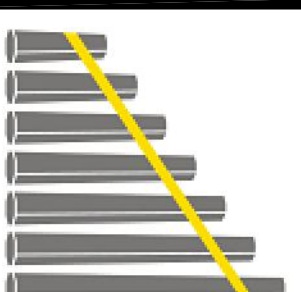
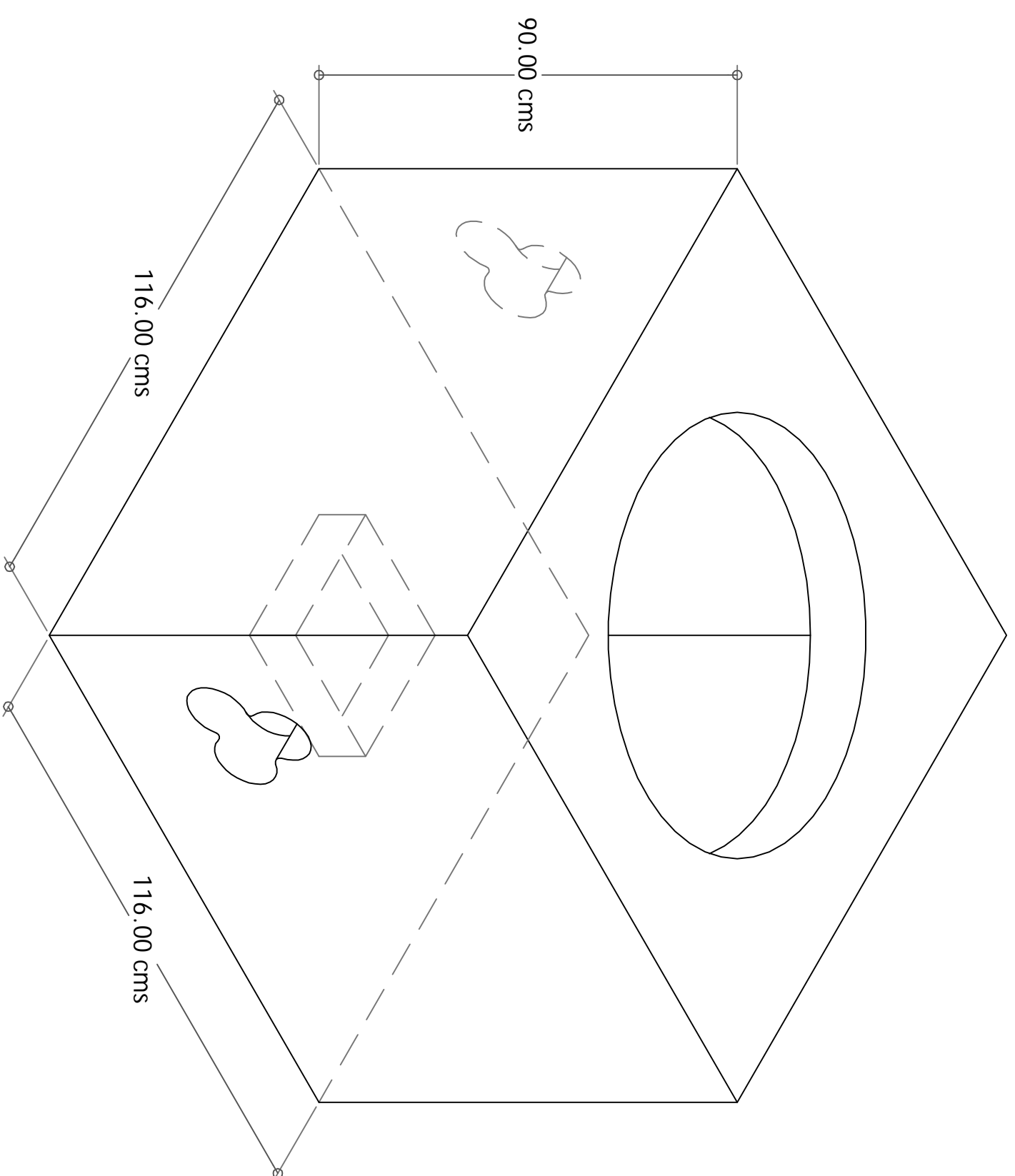

**GRUPO
ELECTRICO
ACONCAGUA**

CFE - RMTA3

EN ARROYO

REGISTRO PARA MEDIA TENSION
EN ARROYO TIPO 3

CFE **norma** **de** **Construcción**
Distribución- Construcción
de Sistemas subterráneos